

Development of an Air Quality Measurement Module for an Aquatic Mobile Robot

**Department of Mechanical and Aerospace Engineering
Dynamical Systems Laboratory**

Channa Comer – Baychester Middle School, Bronx, NY

Dwight Young, I.S. 285, Brooklyn, NY

Brooklyn Atlantis Project

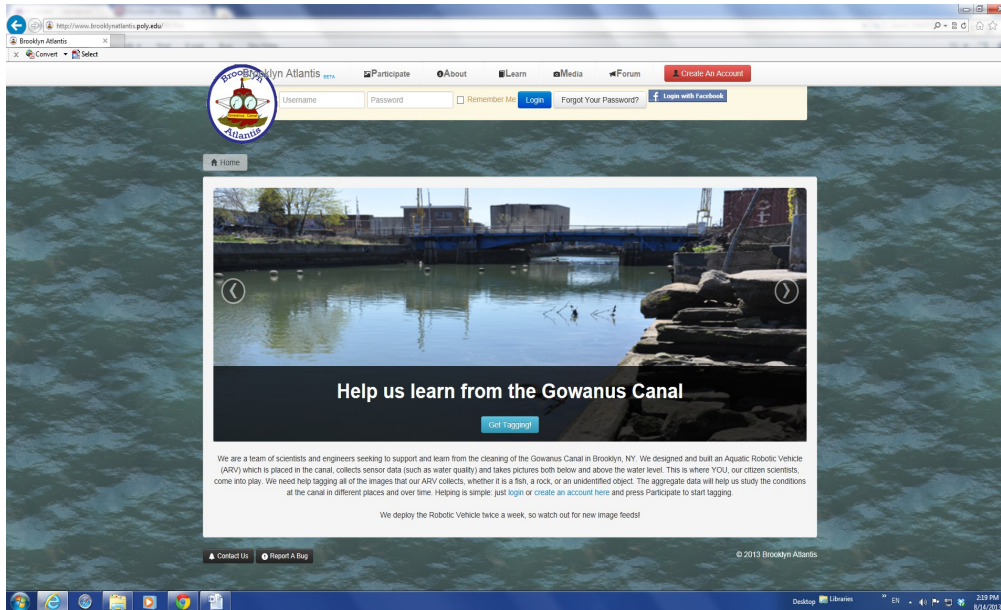

- Citizen science project started in 2011
- Objectives
 - develop a model which will enable members of the public to take part in scientific research through the combined use of machines and a web-based peer production system operated by volunteers
 - develop a cyber-human infrastructure for real-time monitoring and hazard detection of the natural environment
- marine sensor units are mounted on an aquatic mobile robot which is deployed into the Gowanus Canal in Brooklyn, New York, once each week to collect water quality data
 - dissolved oxygen
 - pH
 - water temperature
 - Conductivity
- Potographs
 - above and below water
- Members of the public register on the web portal, tag images and have access to the water quality data.

Air Quality Monitoring Module

- Enhance environmental monitoring capabilities of the robot with the development of a low-cost sensor array module to collect air quality and associated weather data:
 - Carbon Monoxide (CO)
 - Volatile Organic Compounds (VOCs)
 - Nitrogen Dioxide
 - Ozone
 - Temperature
 - Relative Humidity
 - Barometric Pressure

The Gowanus Canal

GOWANUS CANAL FORESTRY STUDY AREA

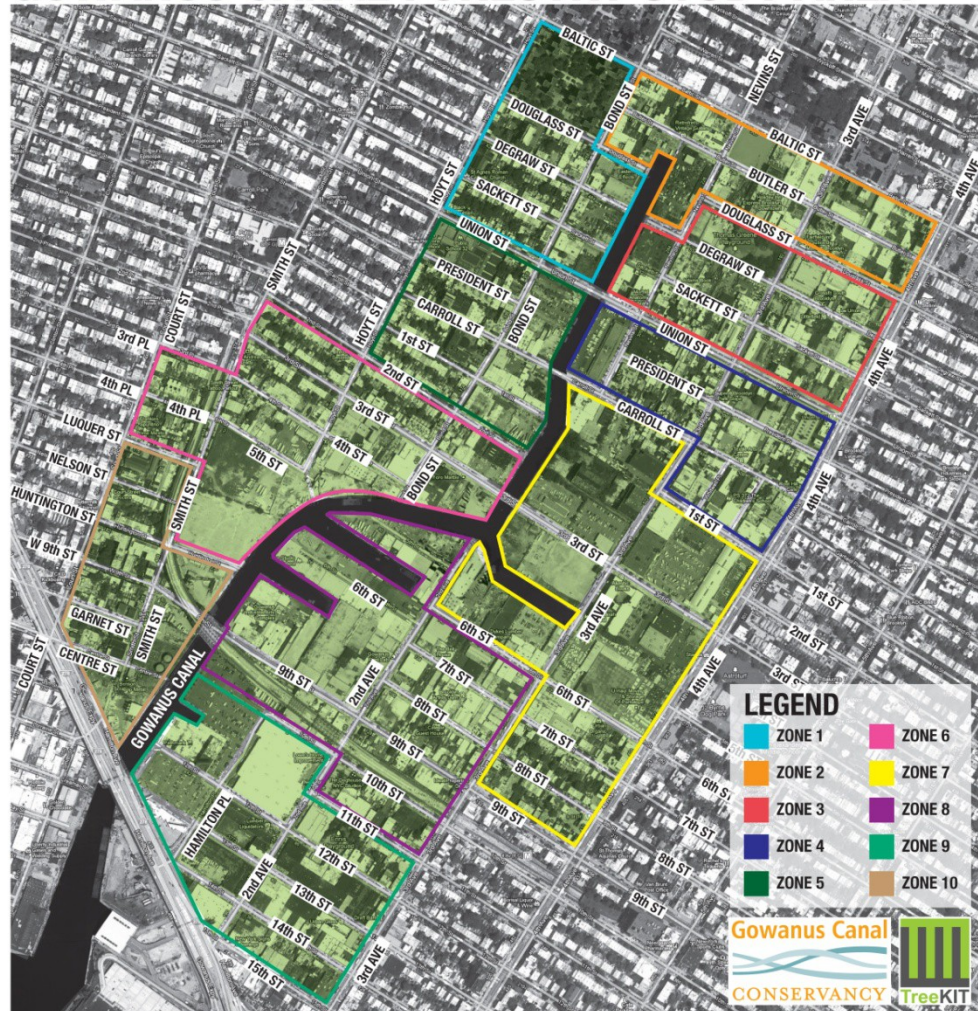

- 1.8 mile long canal
- Bordering the neighborhoods of Red Hook, Park Slope, South Brooklyn and Sunset Park
- connected to the Upper New York Bay.
- Historically home to a variety of industrial production
 - stone
 - coal
 - flour
 - cement
 - paint
 - ink
 - soap
 - fertilizer and other chemicals
 - gas manufacture of gas.
- Repository for sewage from the neighborhoods surrounding the canal.
- Over the years, the combination of industrial pollutants, runoff from storm water and the discharge of raw sewage has taken its toll
- Placed on the Environmental Protection Agency (EPA) Superfund National Priorities list in 2010

The Robot

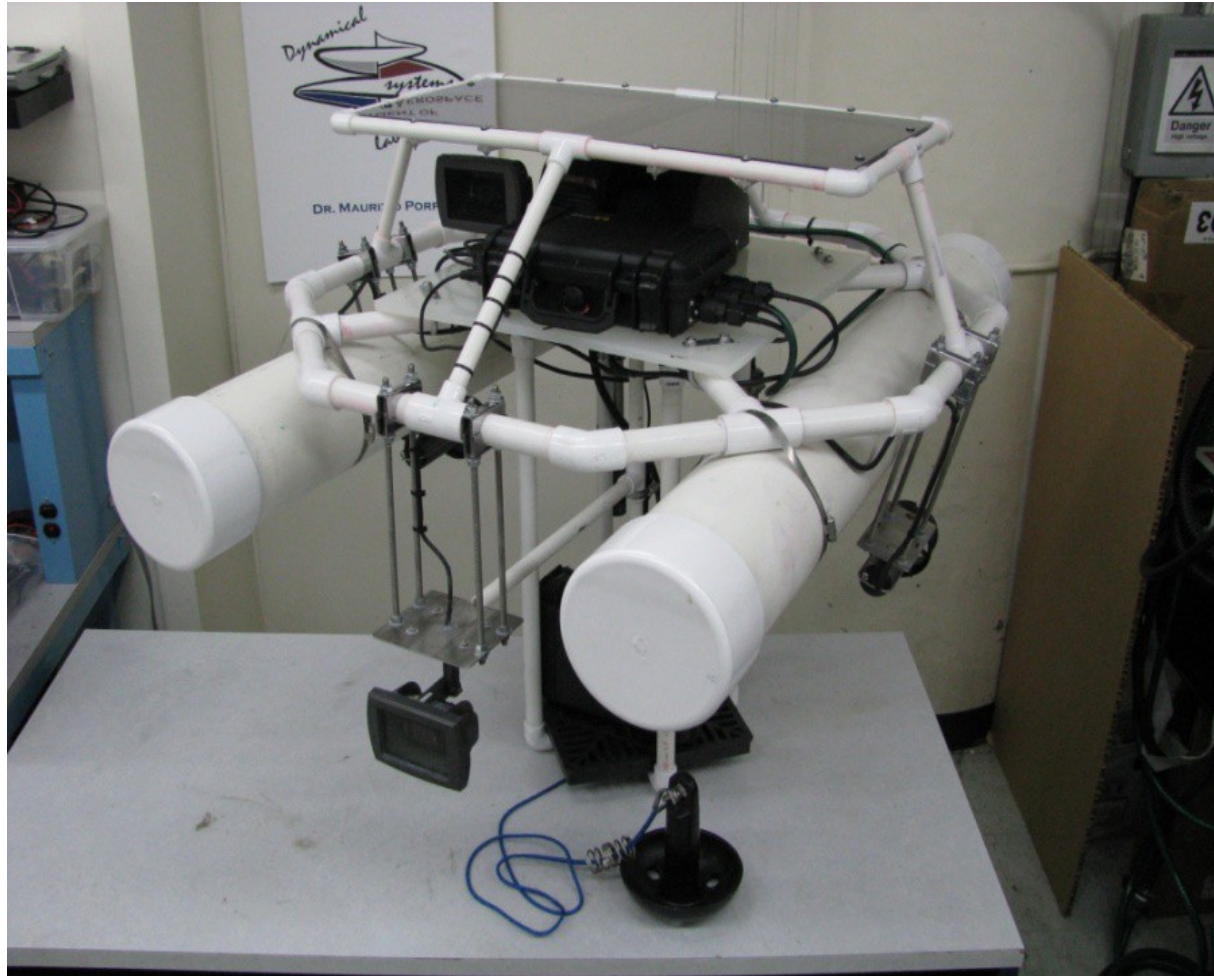

Weekly Robot Deployment



Air Quality Module Development

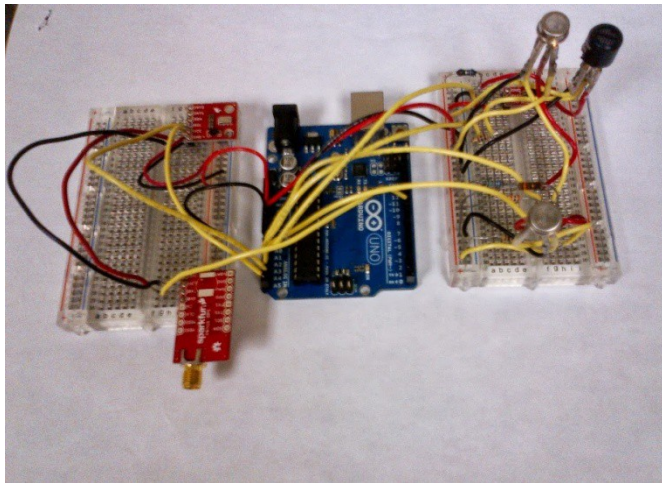

- Arduino Uno Microcontroller

Sensor	Gas Tested For
SGX Sensortech Limited MiCS 5121-WP	CO/VOC
SGX Sensortech Limited MiCS 2610	O3
SGX Sensortech Limited MiCS 2710	NO2

Sensor	Mesurment
Freescale Semiconductor Xtrinsic I2C Precision Altimeter MPL3115A2 Altitude Pressure Sensor	Barometric Pressure, Temperature
Honeywell HIH-4030 Humidity Sensor	Relative Humidity

- Baseline gas sensor readings obtained
- Calculations made to determine values for the readings in parts per million (ppm) for each of the gases.

Field Testing



Who wouldn't need a bath after being in the
Gowanus Canal?



Results

CO/VOC Resistance (Ohms)

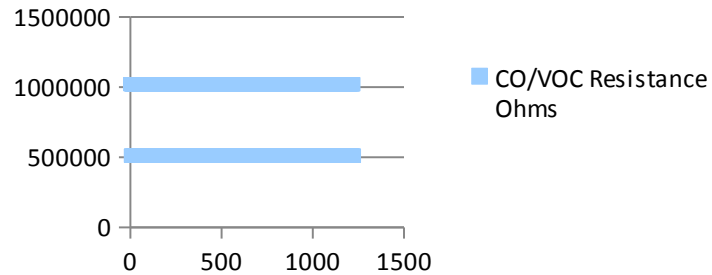

O3 sensor resistance (Ohms)

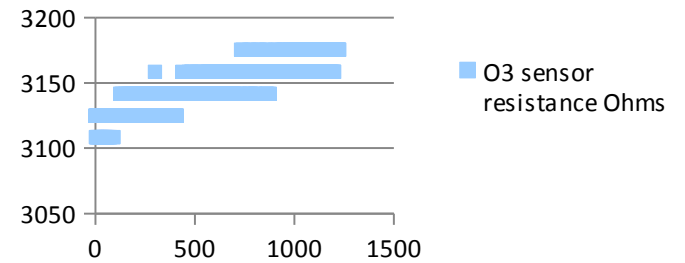

NO2 Resistance (Ohms)

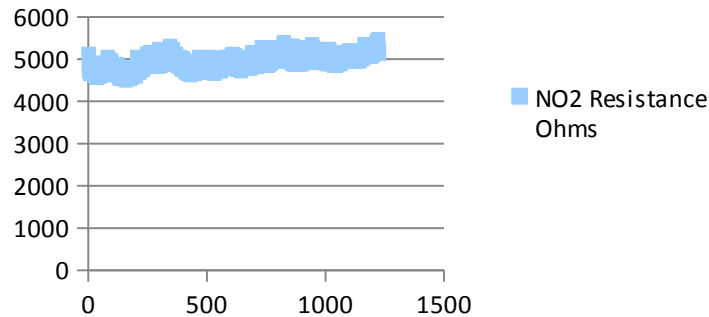

Results

Relative Humidity (%)

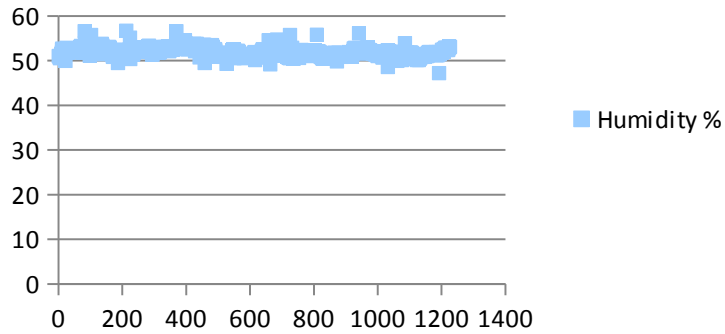

Temp (°C)

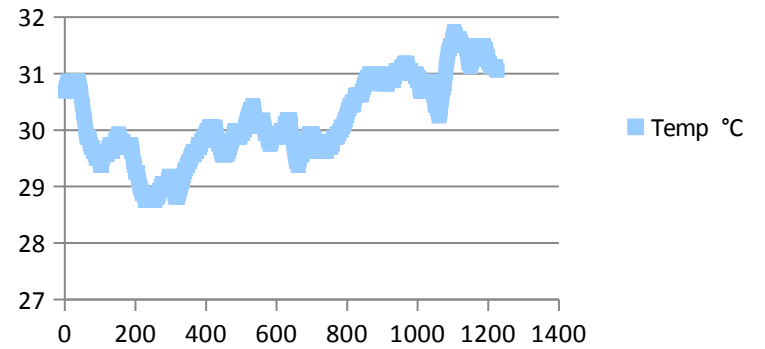

Pressure (KPa)

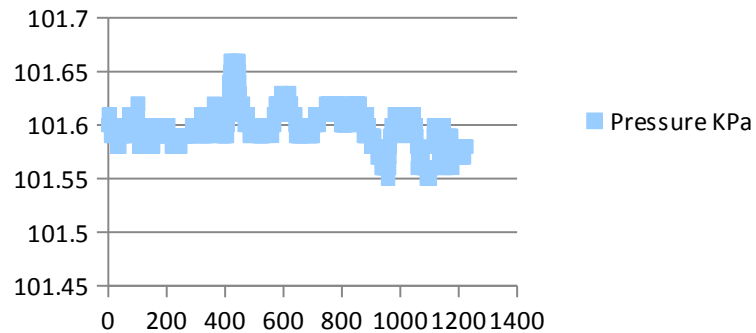

Data Collection Issues

- Gas sensor readings not precise
 - Selection of load resistor
 - Baseline values used
- Data not shown in ppb and ppm

Conclusion and Next Steps

- With the exception of nitrogen dioxide gas sensor readings were inconclusive
- Select more suitable load resistors
- Obtain baseline values in a laboratory setting using calibration gases
- Modify program code to convert gas sensor readings to ppm and ppb
- Solder sensors onto printed circuit

Printed Circuit

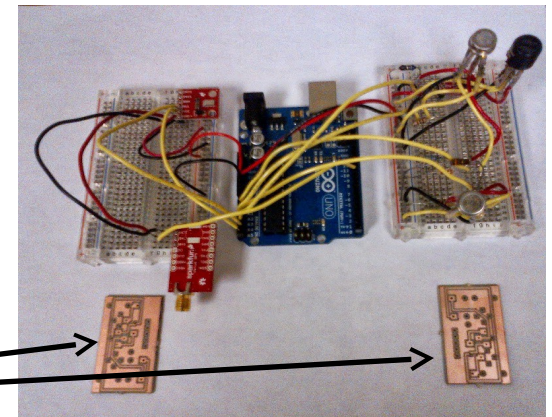

Business Application

Product

- Simple, low-cost mechatronics kits designed for use by middle and high school science teachers who have limited knowledge of electronics and computer programming and are interested in incorporating mechatronics into their existing curriculum.
 - Designed to teach a specific science concept
 - All the required materials
 - Available individually and in bulk
 - Each kit is tested with a panel of teachers prior to full scale development

Example: Build A Weather Sensor

- Kit Components: Arduino microcontroller and USB cable, breadboard, jumper wire, Humidity and Temperature Sensor, LCD Display, 4xAA battery holder, 4 AA batteries, CD with Arduino program code, Step-by-Step instructions and students worksheets.

Competition

Competition

- Direct competitors are vendors who offer mechatronics kits (independent of a robotics system such as LEGO):
- Carl's Electronics (electronic kits store)
- Robot Shop
- Jameco Electronics
- Edmund Scientifics

Competitive advantage: Each kit is specifically aligned to middle school science core curriculum standards and can be easily incorporated into existing unit without requiring the teacher to have extensive knowledge of robotics, computer programming or mechatronics.

Marketing

Marketing

- The kits would be marketed through several avenues:
- Online via internet web catalog.
- Through various school science supply vendors (Carolina Biologicals, Wards Scientific, Science Project Store, etc.)
- In-Person Presentations/Demonstrations
 - science fairs
 - science teacher conferences (i.e., STANYS, NSTA, etc.)
 - in-school demonstrations
 - professional development programs for science teachers (Columbia University Summer Research Program for Science Teachers, Sci-Ed Innovators, NYU Polytech SMARTER program, Math for America, New York Hall of Science Maker Fair, etc.)

Classroom Application

- Lesson plans in development
 - Students build temperature/humidity sensor
 - Engineering design activity to develop housing for sensor.
 - Students build device to measure greenhouse gases.

Thank You!

Acknowledgements

- Dr. Vikram Kapila
- Dr. Oded Nov
- Dr. Maurizio Profiri
- Jeffrey Laut

*** This work was supported by the National Science Foundation under grant EEC-1132482, "RET Site: Science and Mechatronics Aided Research for Teachers with an Entrepreneurship experience (SMARTER)."*